

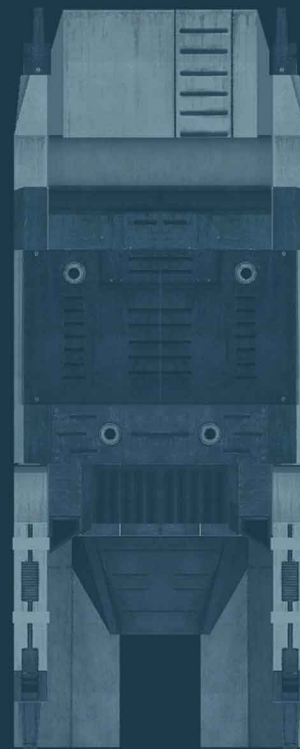

# UT-47 KODIAK DROP SHUTTLE



A THUNDERCHILD PAPERMODEL



# MASS EFFECT 2



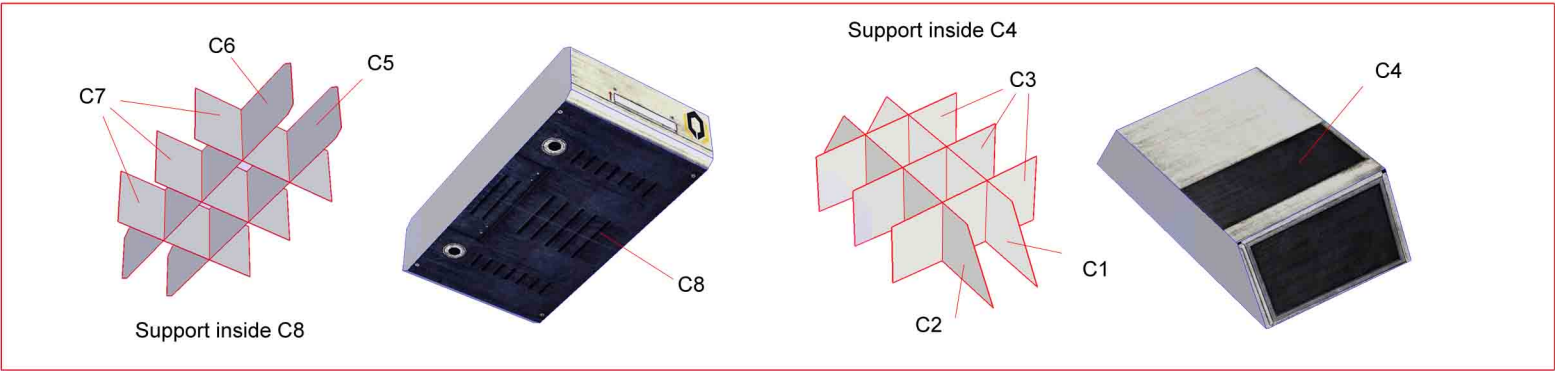
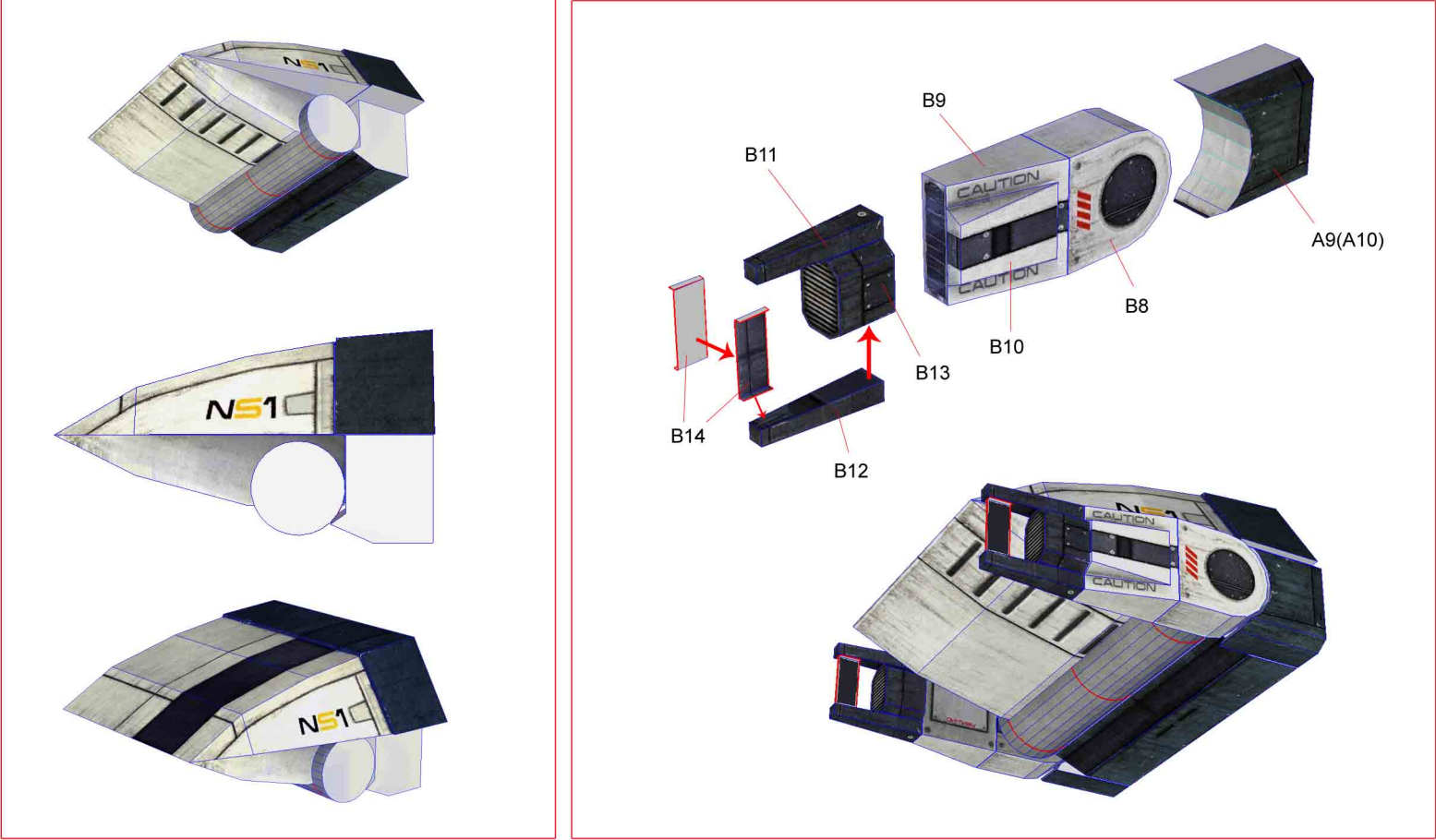
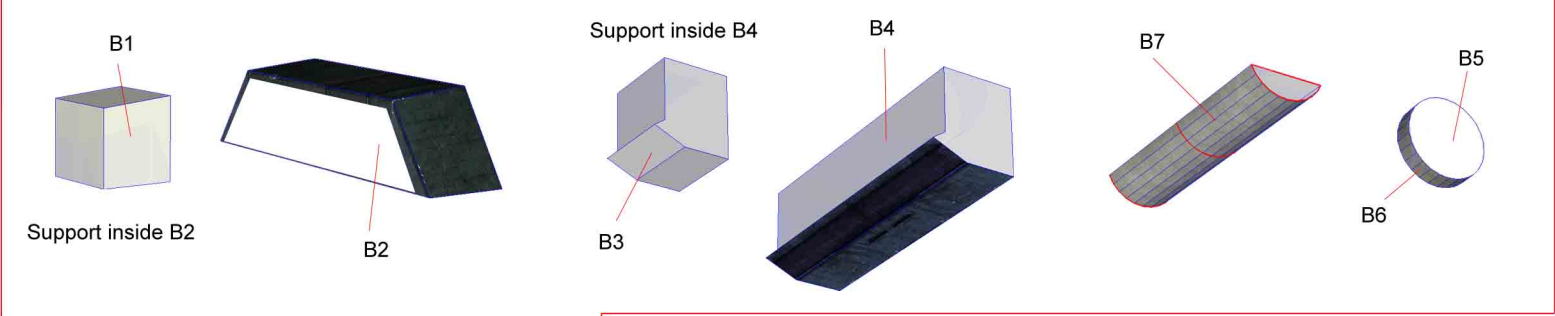
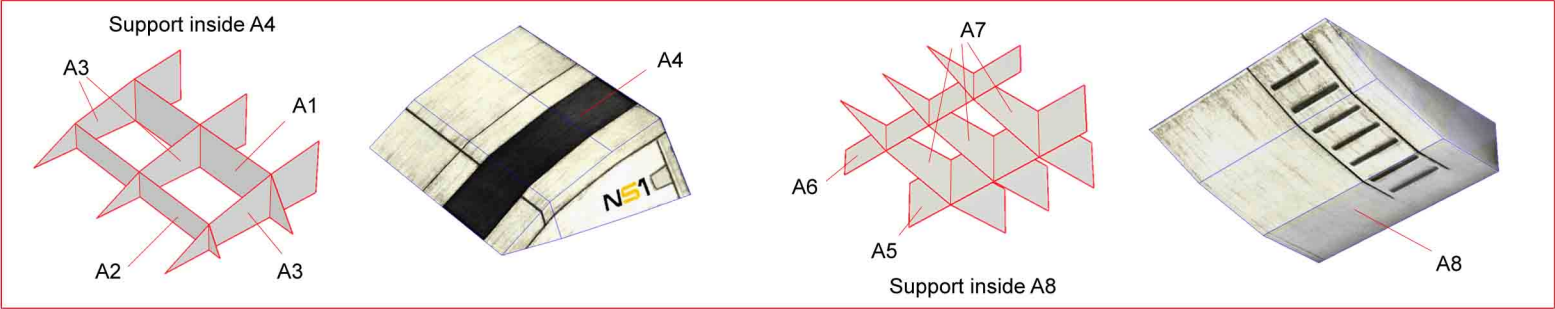

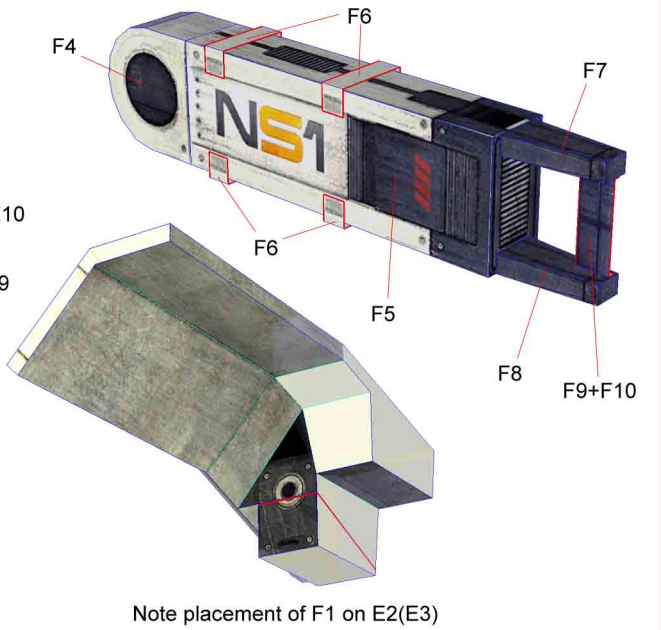
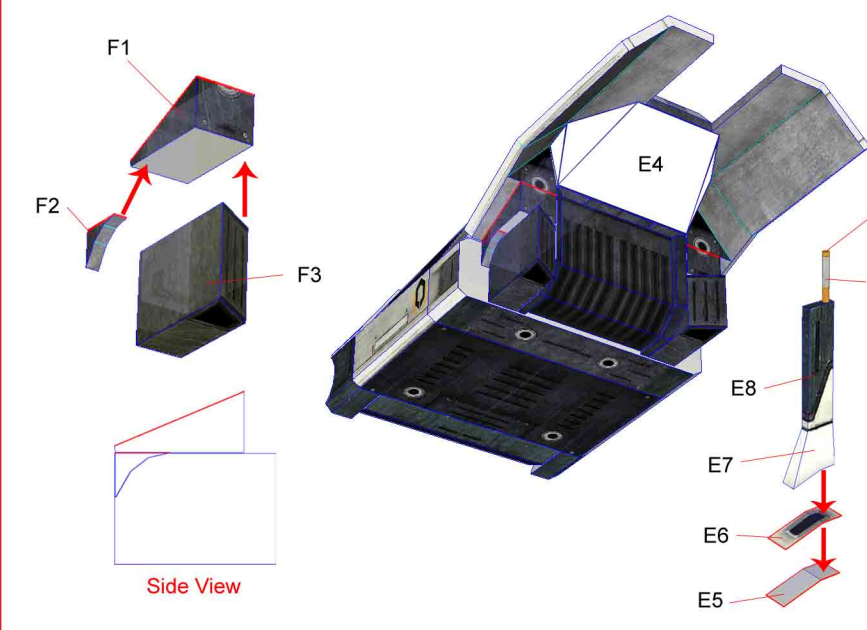
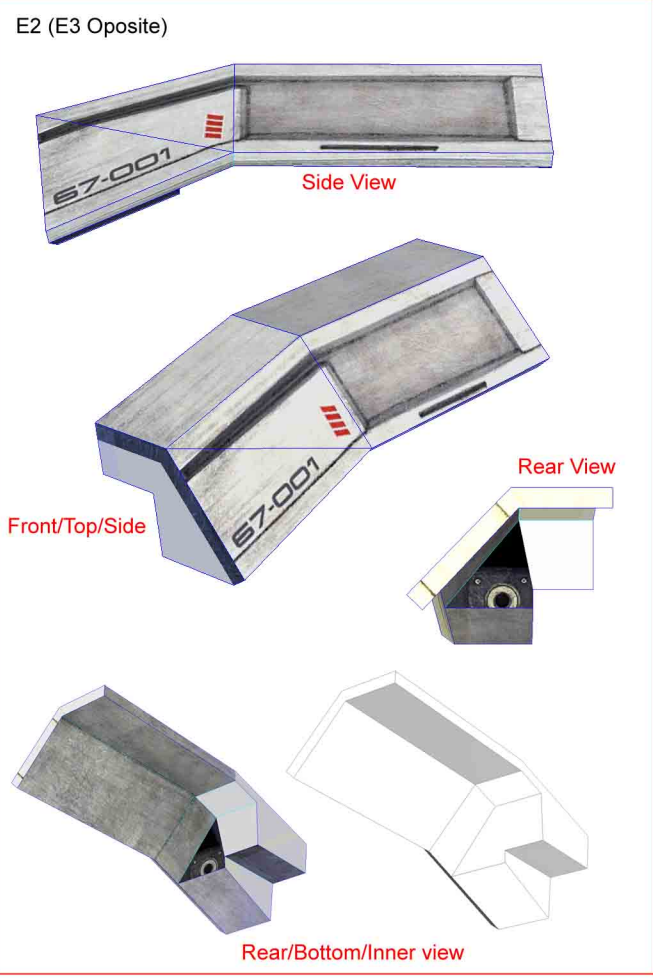
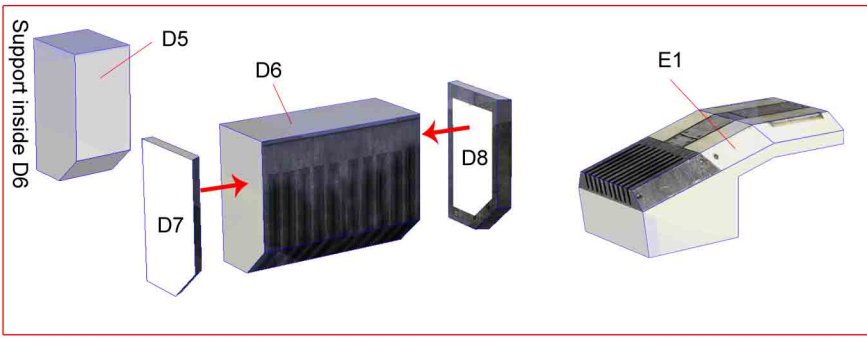
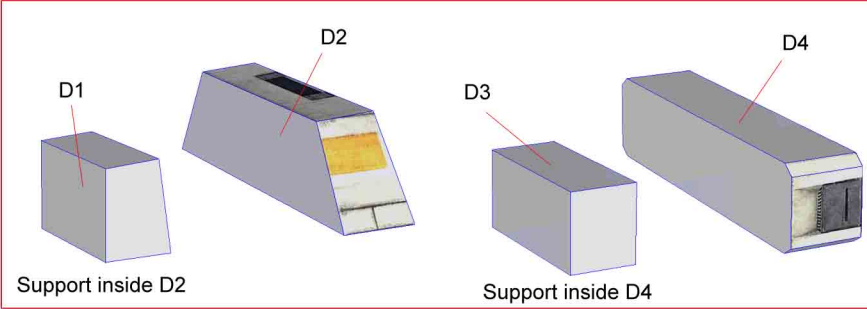

## REFERENCE IMAGES

All copyrights remain with  
the original creators:  
BIOWARE

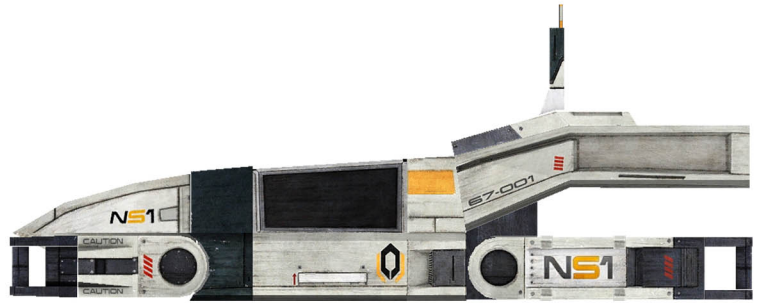

This model is provided  
free and is **NOT** to be sold!

Do **NOT** distribute this model  
without the Author's permission

Author: ThunderChild  
[thunderchild\\_pdp@yahoo.com](mailto:thunderchild_pdp@yahoo.com)

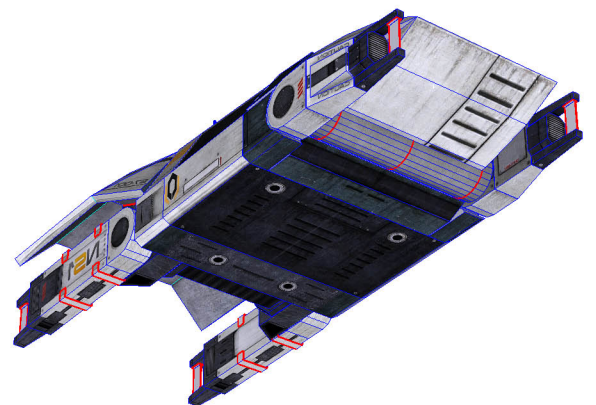
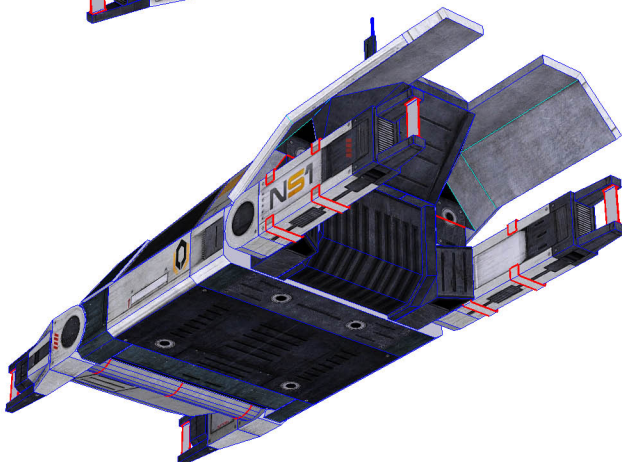
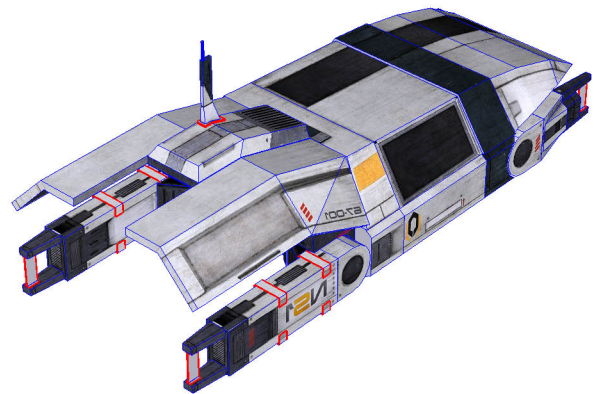
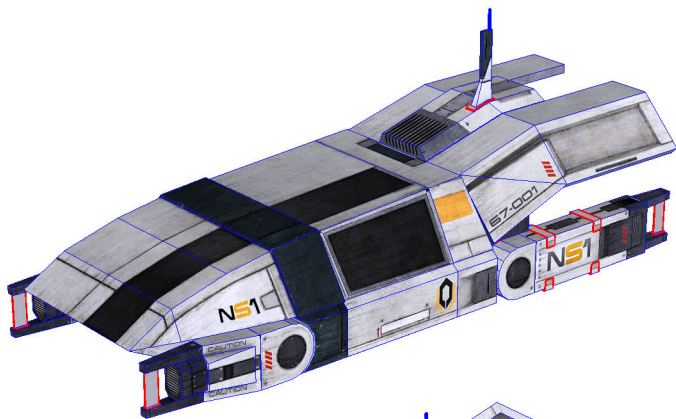
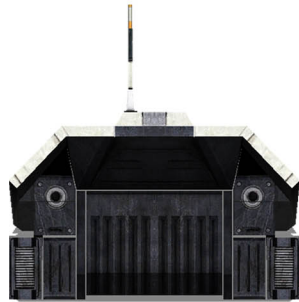
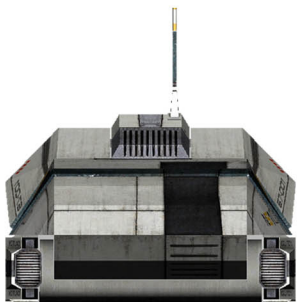
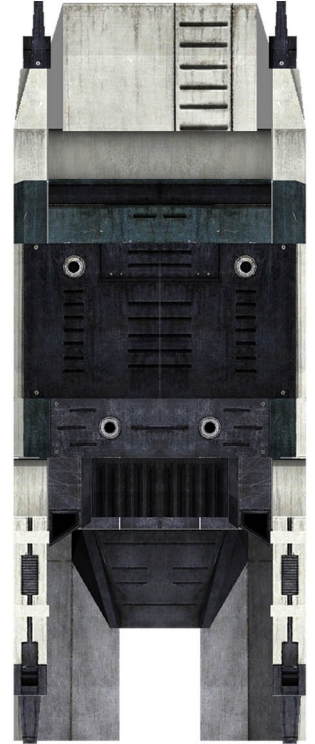
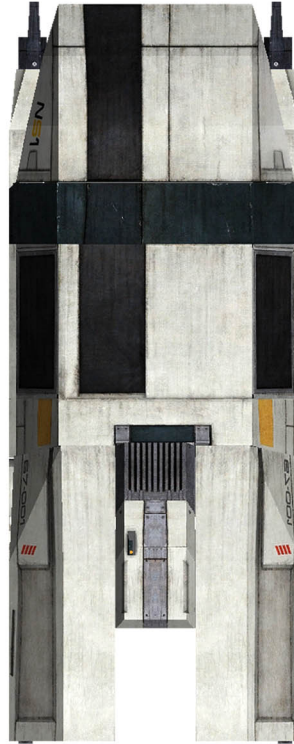

A

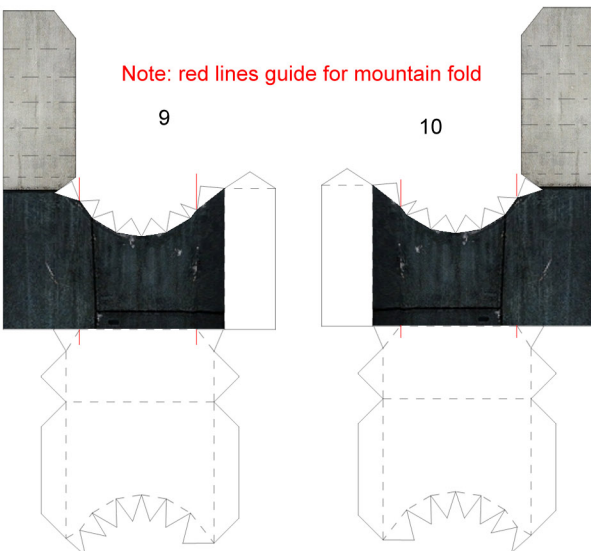
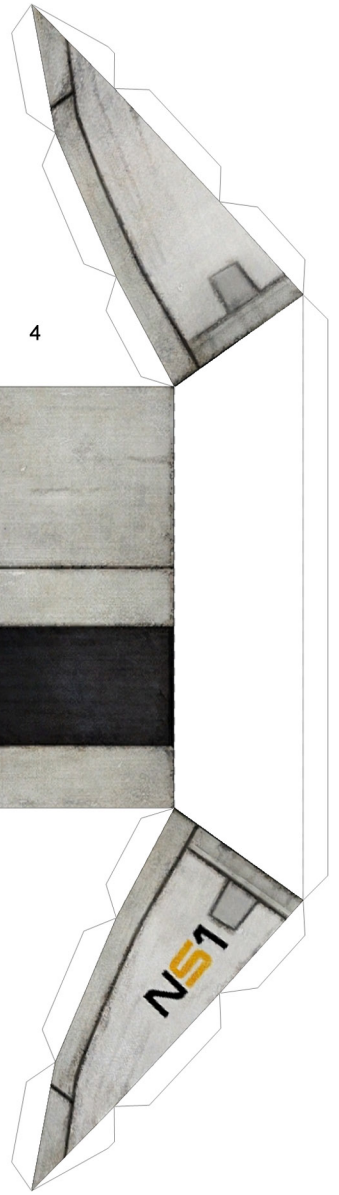
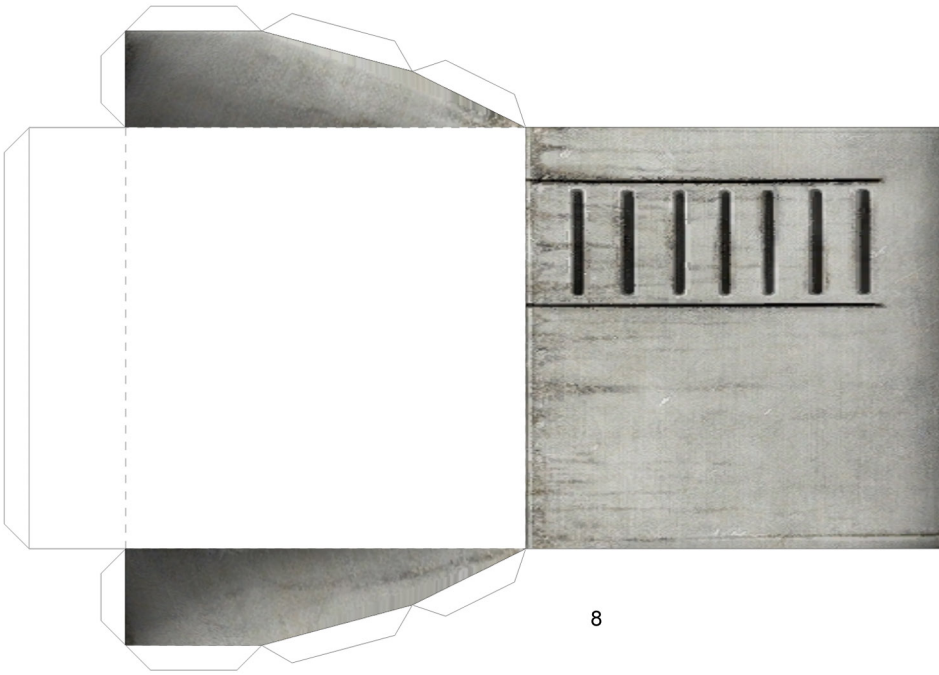
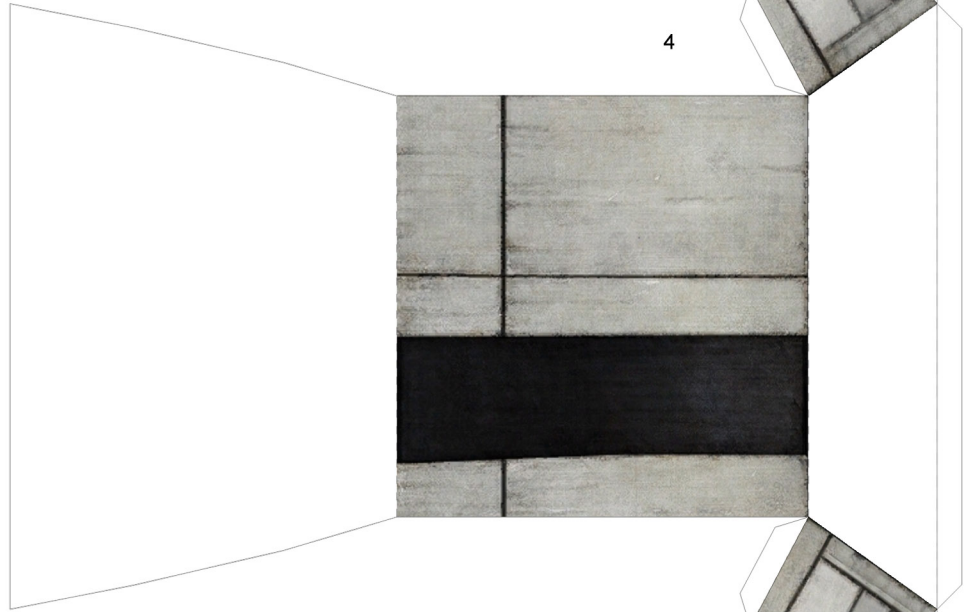
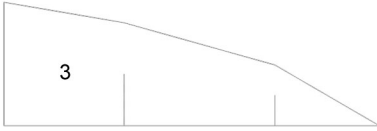
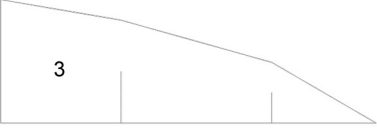
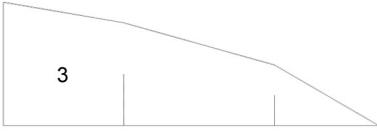

B

Note: red lines guide for mountain fold

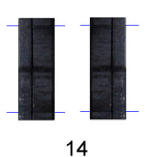
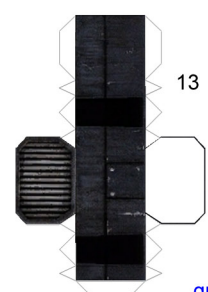
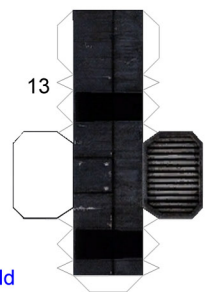
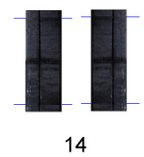
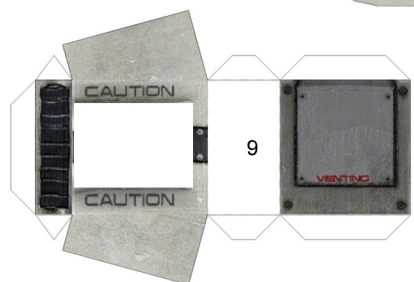
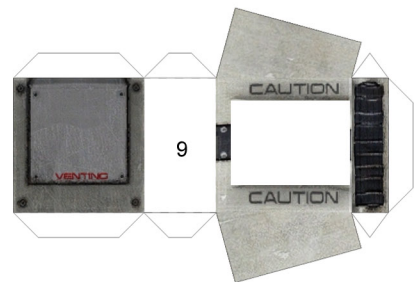
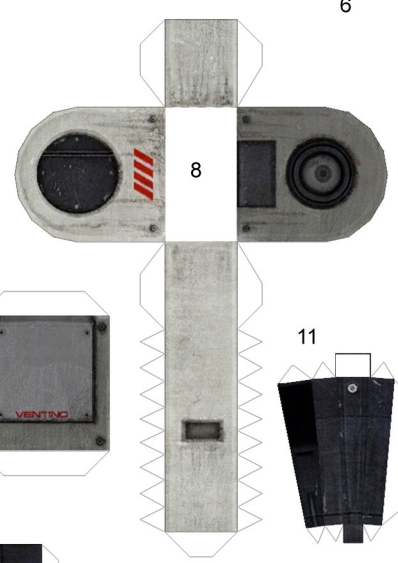
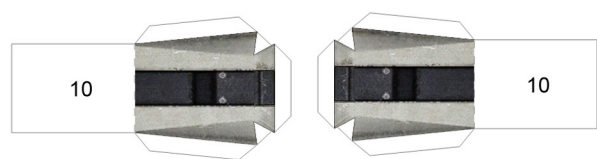
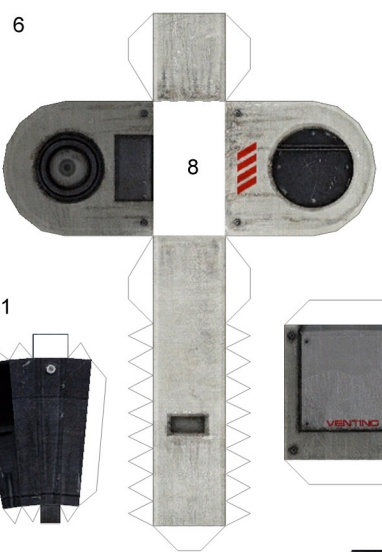
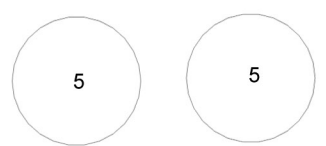
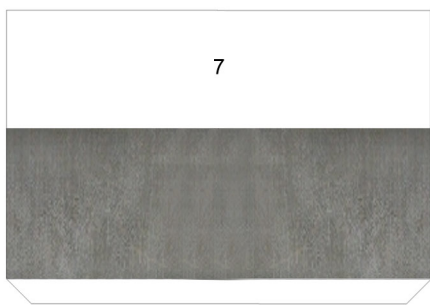
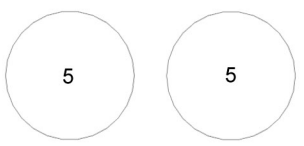
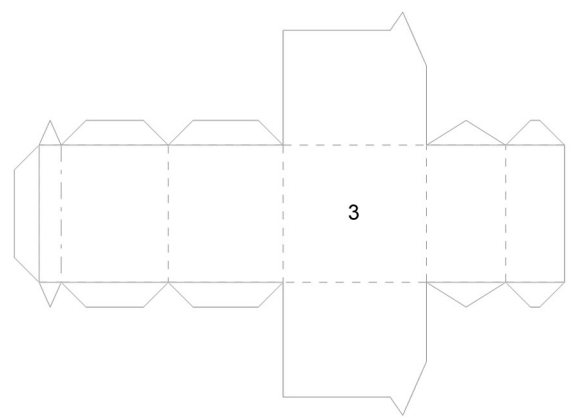
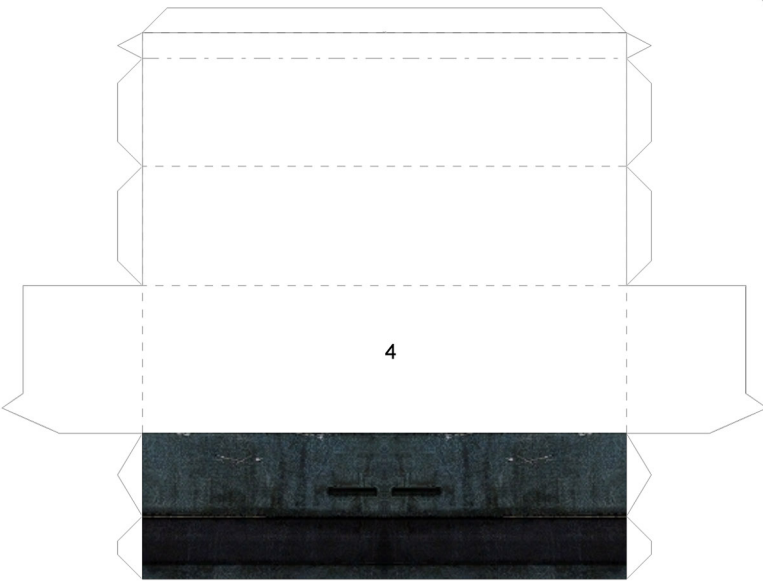
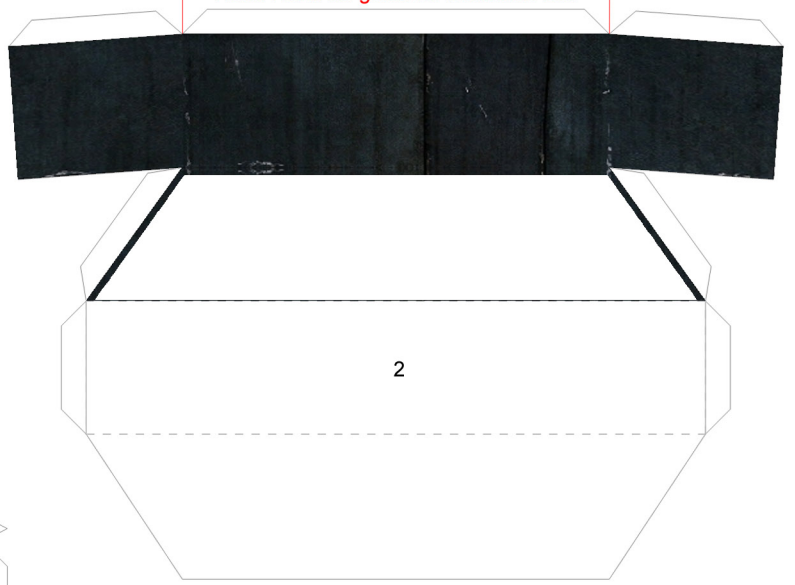
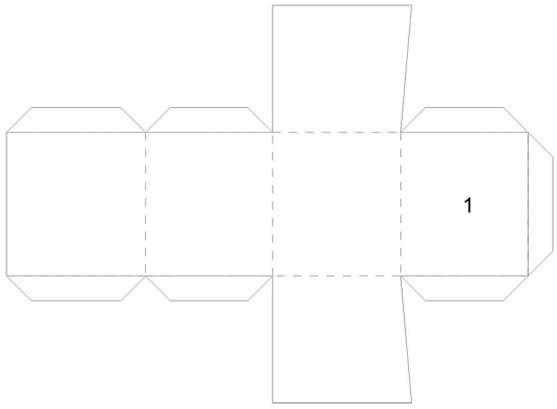

Note: blue lines guide for valley fold

Note: blue lines guide for valley fold

C

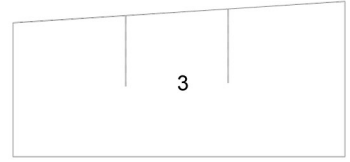
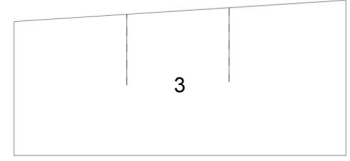
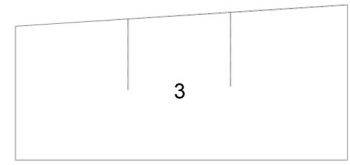
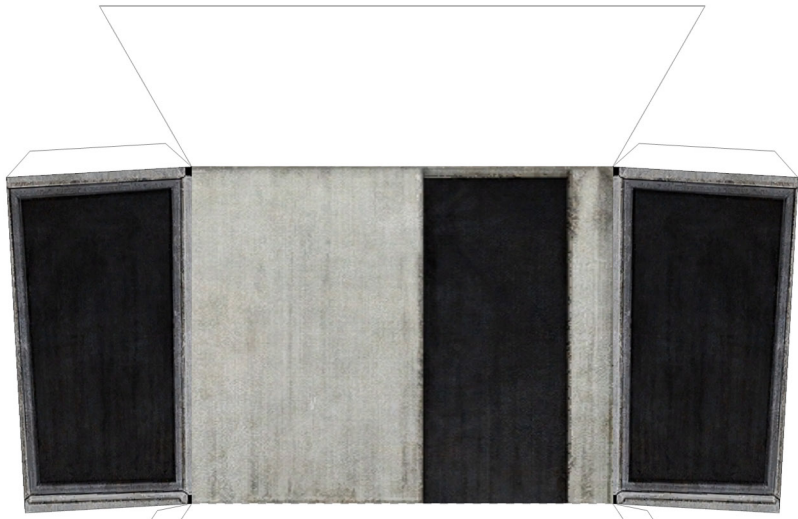

4

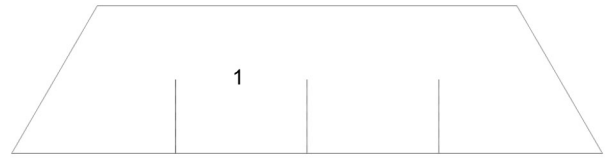
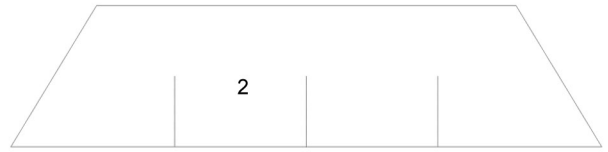
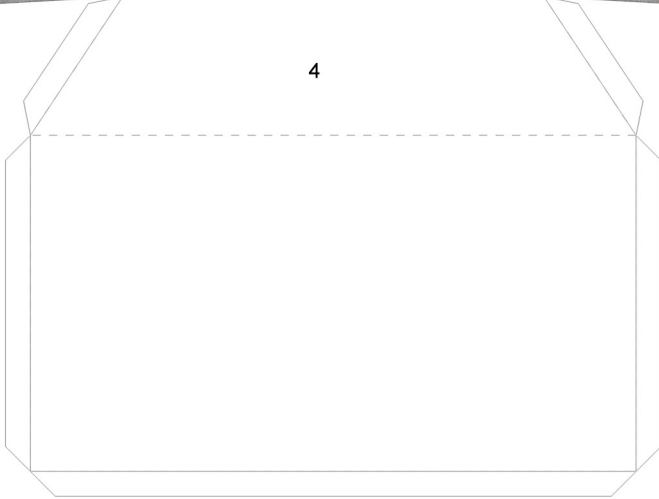

Note: red lines guide for mountain fold

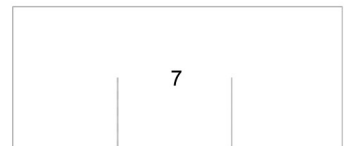
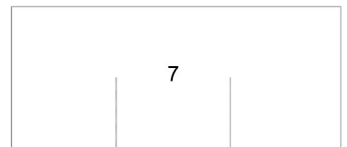

8

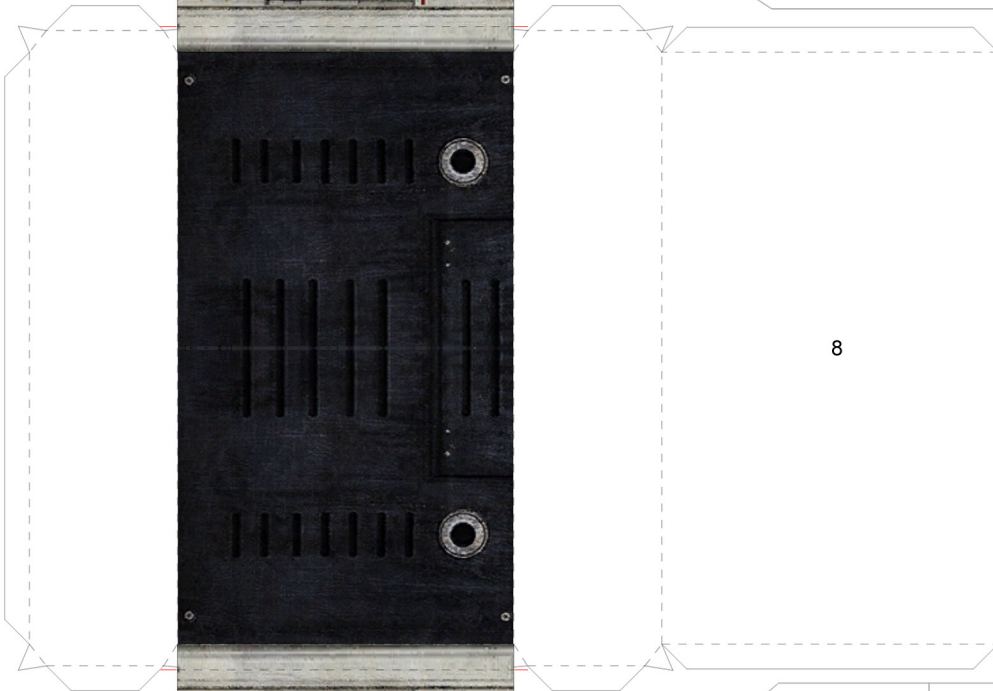

6



D

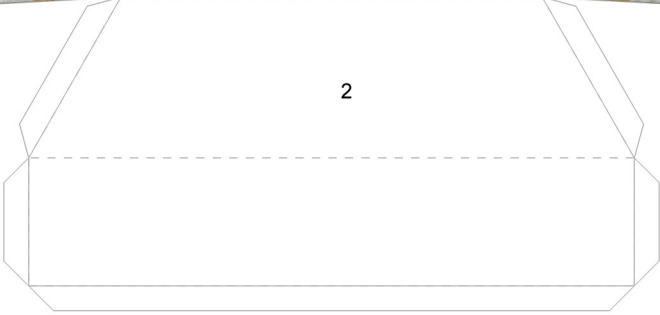
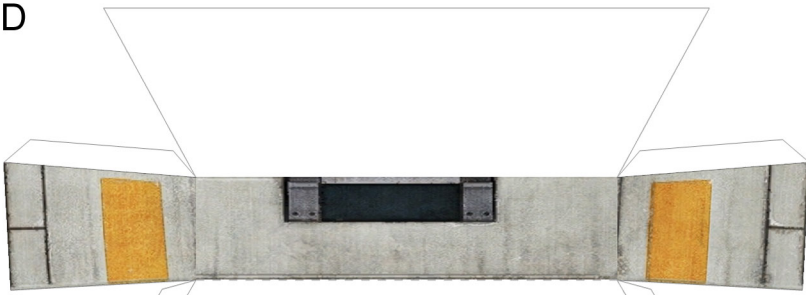

2

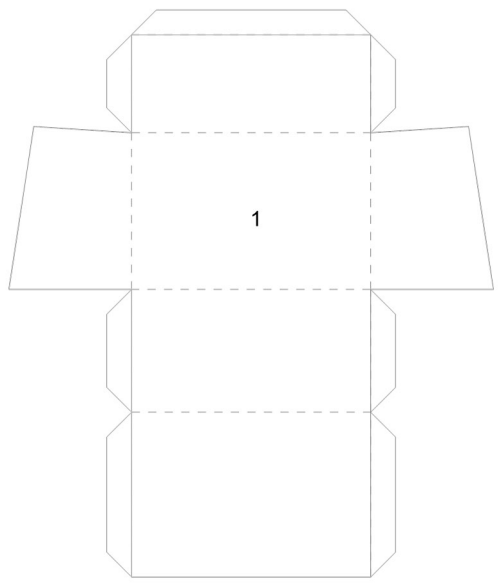

1

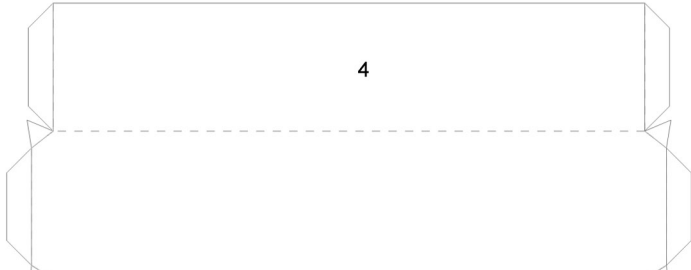

4

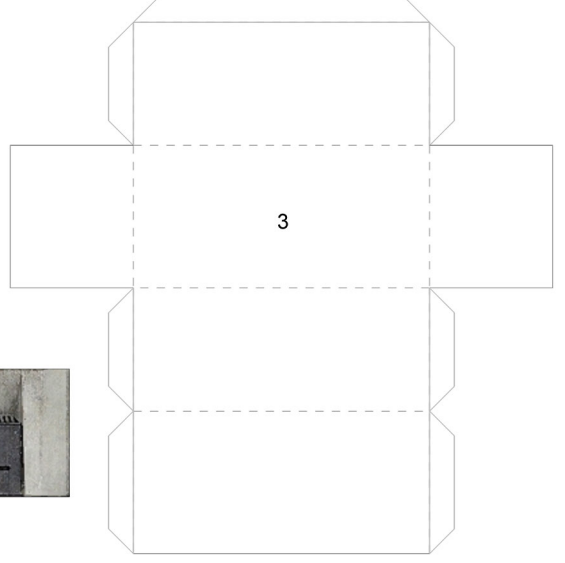

3

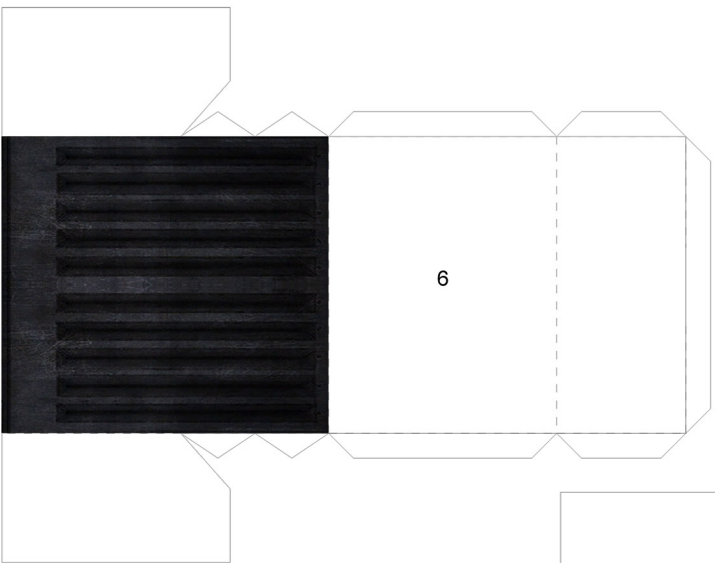
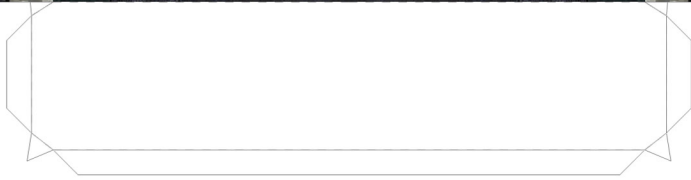

6

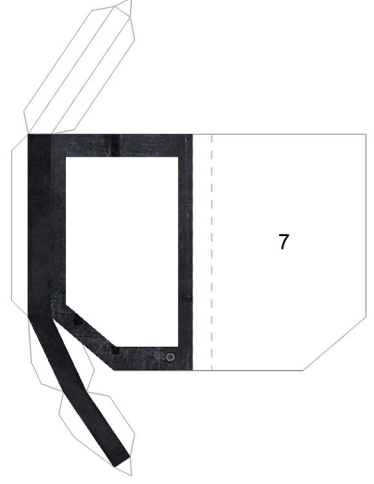

7

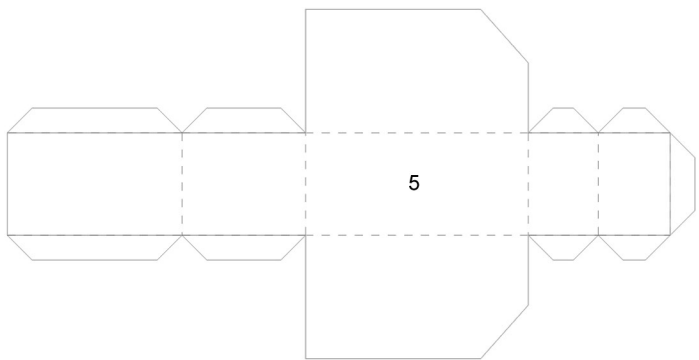

5

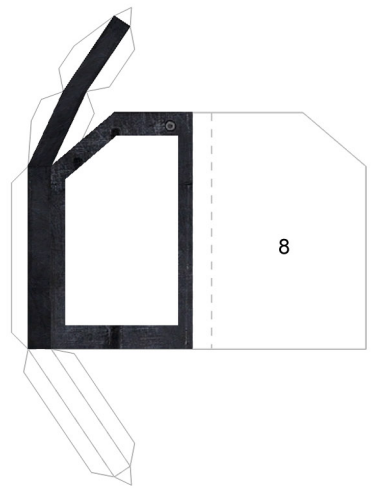

8



E



8



7

10



9



5

6

5

6

Note: red lines guide for mountain fold  
and blue lines guide for valley fold

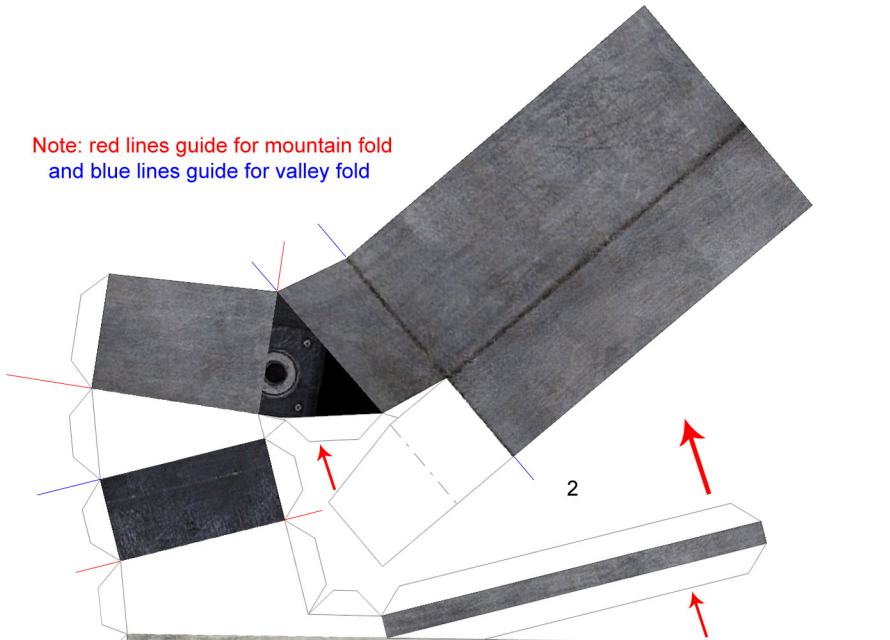

2

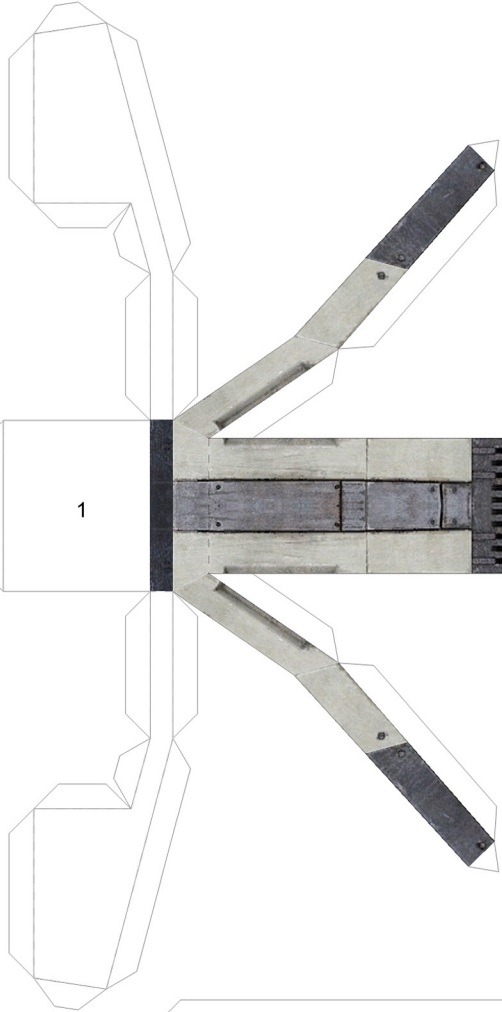

1

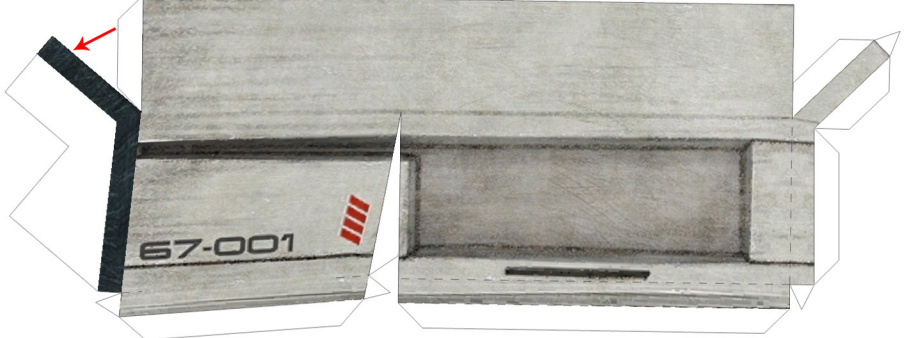

67-001



4

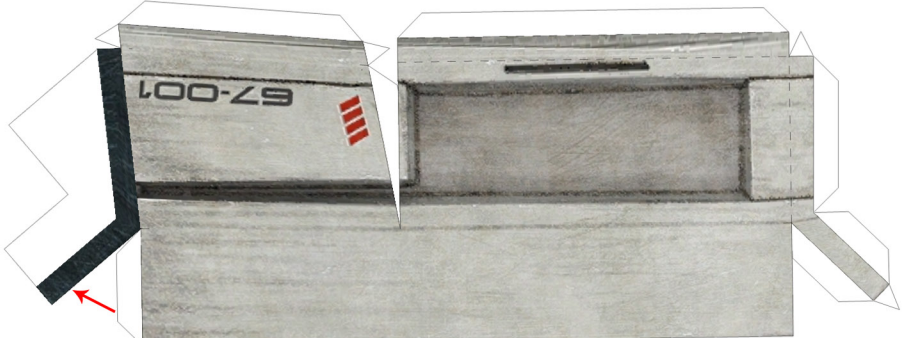

100-29



3

Note: red lines guide for mountain fold  
and blue lines guide for valley fold

F

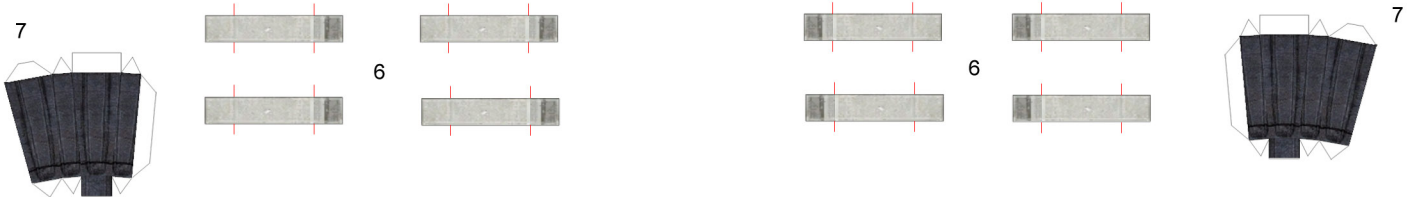
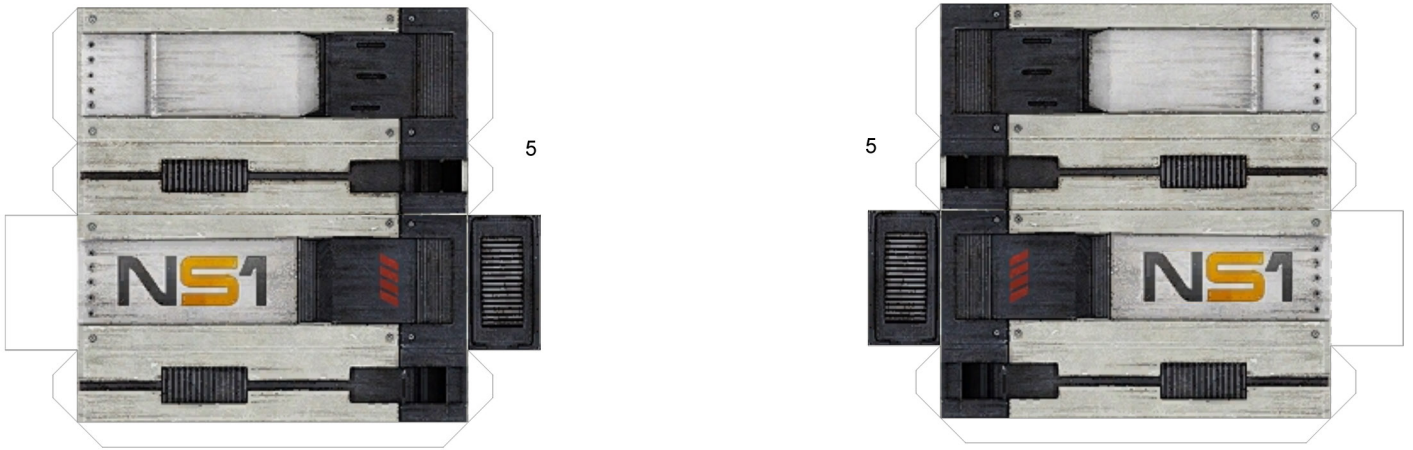
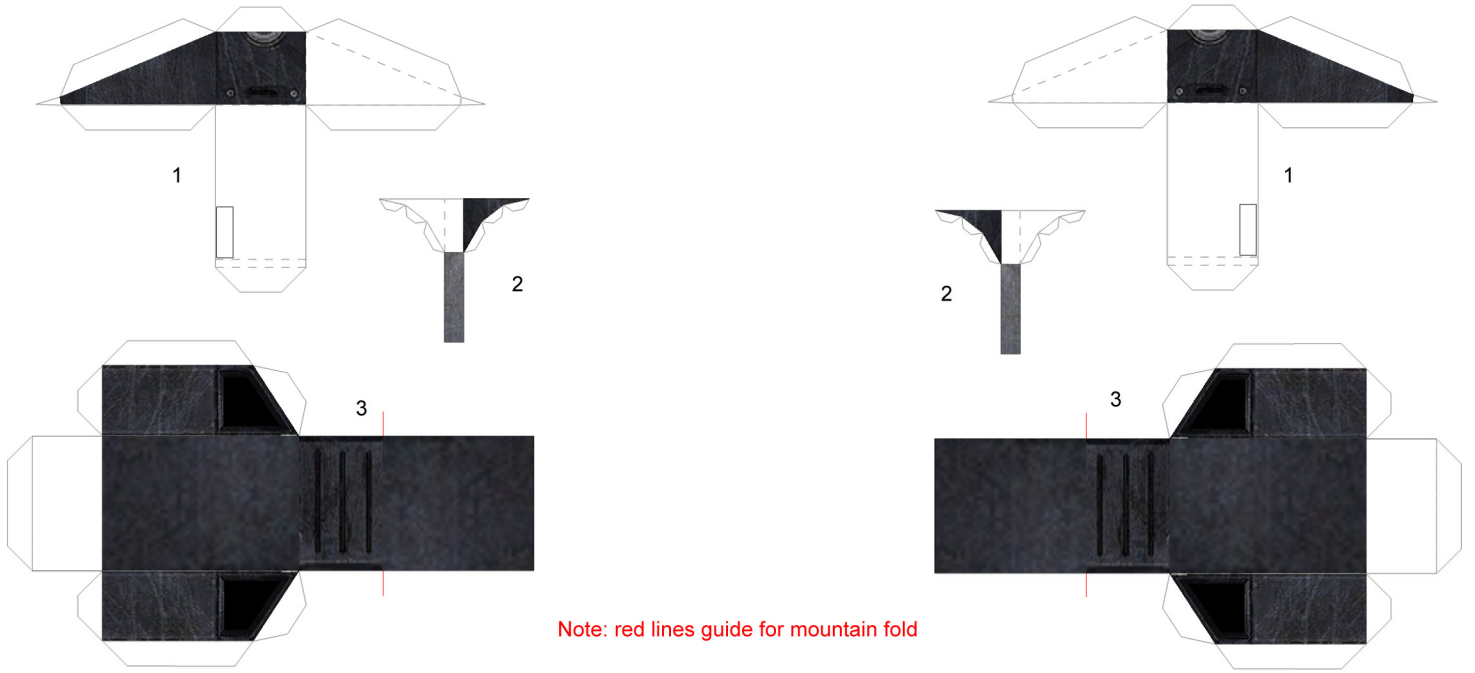

Note: red lines guide for mountain fold  
and blue lines guide for valley fold

